

Pro-Line Series™

Ladder Pull Handle

Back to Back

Suitable for Glass, Wood and Metal Doors

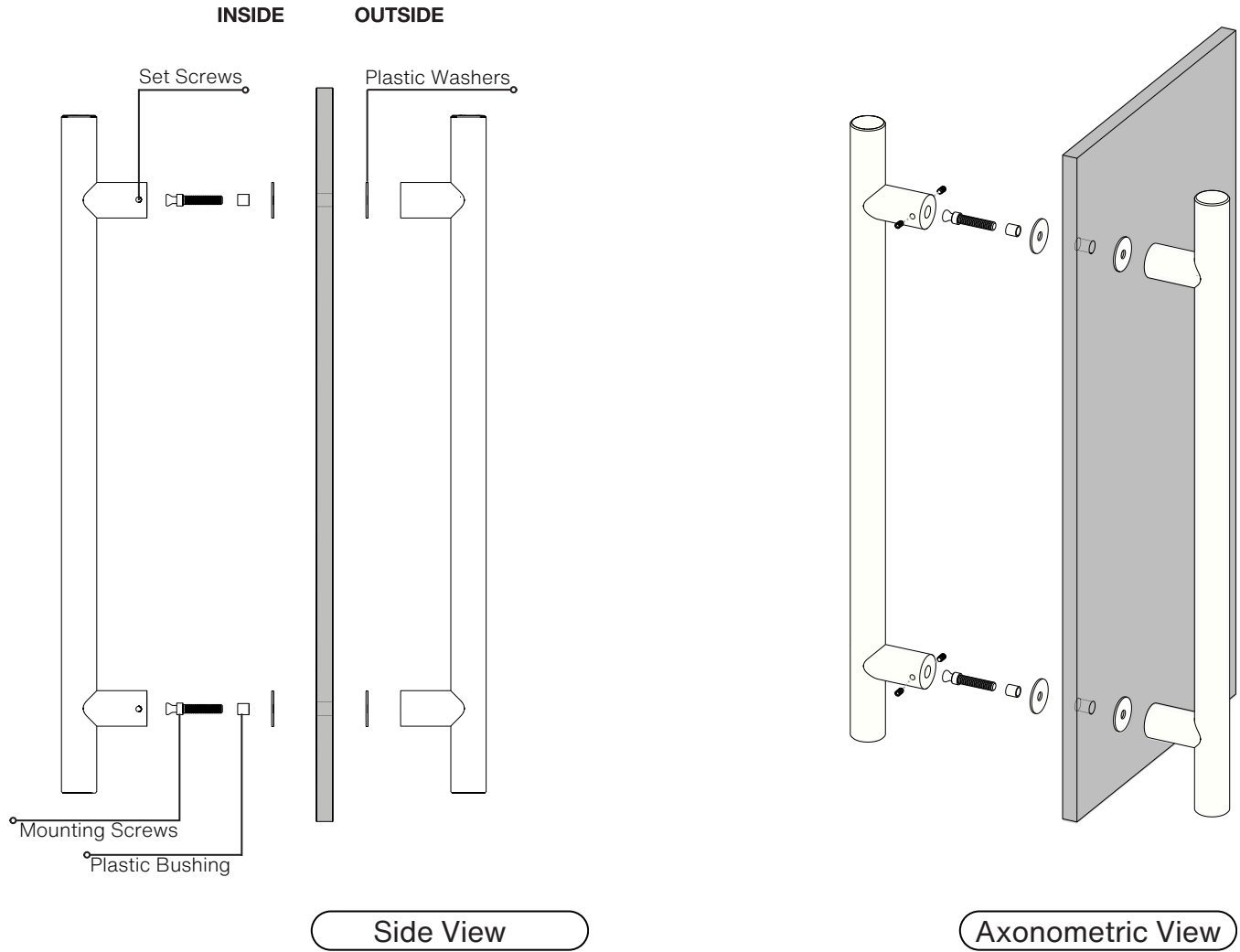

Side View

Axonometric View

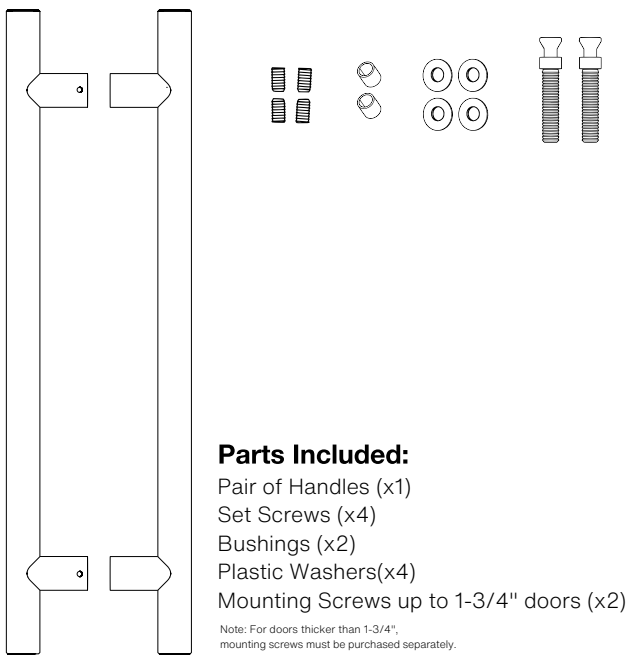

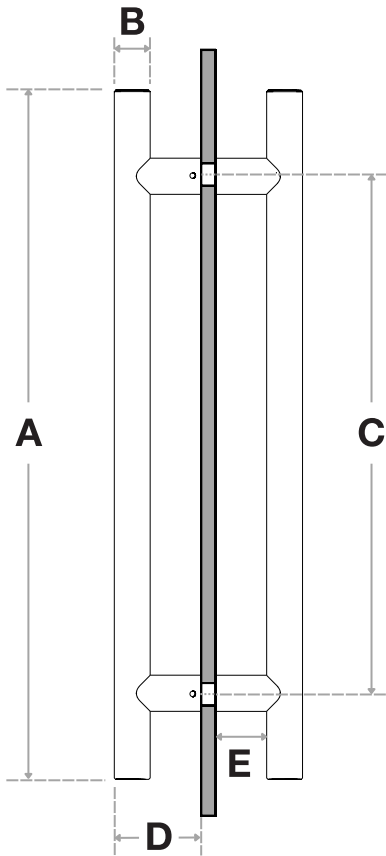











Side View

Handle Length (A)	Diameter (B)	Center-to-Center (C)	Projection (D)	Clearance (E)
12"	1"	6"	2-3/4"	1-3/4"
16"	1"	10"	2-3/4"	1-3/4"
18"	1"	12"	2-3/4"	1-3/4"
24"	1"	18"	2-3/4"	1-3/4"
32"	1"	26"	2-3/4"	1-3/4"
36"	1"	30"	2-3/4"	1-3/4"
48"	1"	42"	2-3/4"	1-3/4"
60"	1"	54"	2-3/4"	1-3/4"
72"	1"	66"	2-3/4"	1-3/4"
84"	1"	60"	2-3/4"	1-3/4"

Handle Length (A)	Diameter (B)	Center-to-Center (C)	Projection (D)	Clearance (E)
12"	1-1/4"	6"	3"	1-3/4"
16"	1-1/4"	10"	3"	1-3/4"
18"	1-1/4"	12"	3"	1-3/4"
24"	1-1/4"	18"	3"	1-3/4"
32"	1-1/4"	26"	3"	1-3/4"
36"	1-1/4"	30"	3"	1-3/4"
48"	1-1/4"	42"	3"	1-3/4"
60"	1-1/4"	54"	3"	1-3/4"
72"	1-1/4"	66"	3"	1-3/4"
84"	1-1/4"	60"	3"	1-3/4"

Handle Length (A)	Diameter (B)	Center-to-Center (C)	Projection (D)	Clearance (E)
12"	1-1/2"	6"	3-1/4"	1-3/4"
16"	1-1/2"	10"	3-1/4"	1-3/4"
18"	1-1/2"	12"	3-1/4"	1-3/4"
24"	1-1/2"	18"	3-1/4"	1-3/4"
32"	1-1/2"	26"	3-1/4"	1-3/4"
36"	1-1/2"	30"	3-1/4"	1-3/4"
48"	1-1/2"	42"	3-1/4"	1-3/4"
60"	1-1/2"	54"	3-1/4"	1-3/4"
72"	1-1/2"	66"	3-1/4"	1-3/4"
84"	1-1/2"	60"	3-1/4"	1-3/4"

FINISHES (1):

-  Brushed Satin = S
-  Polished = P
-  Matte Black Powder Coated = B
-  Bronze Powder Coated = BR
-  Oil Rubbed Bronze = ORB
-  Satin Brass = SB
-  Polished Brass = PB
-  Matte White Powder Coated = W
-  Matte GunMetal Grey = MG
-  Polished GunMetal Grey = PG

OVERALL LENGTHS (2)

- 12" = 12
- 16" = 16
- 18" = 18
- 24" = 24
- 32" = 32
- 36" = 36
- 48" = 48
- 60" = 60
- 72" = 72
- 84" = 84

DIAMETERS (3)

- 1" = 1000
- 1-1/4" = 1250
- 1-1/2" = 1500

For a complete **SKU#** add Finish (1), Overall length (2) and Diameter (3)

SH-PRO-304-LPH - - -
FINISH OVERALL LENGTH DIAMETER

DOOR TYPE	GLASS DOORS UP TO 3/4"	WOOD & METAL DOORS. UP TO 4-3/4"
HOLE SIZE DIAMETER	5/8"	5/16"

Not all Finishes, Lengths and Diameters are available in this style.

For customization requests, please contact us at info@strongarhardware.com