

Pro-Line Designer Series™

Fluted Ladder Pull Handle

Back to Back

Suitable for Glass, Wood and Metal Doors

INSIDE

OUTSIDE

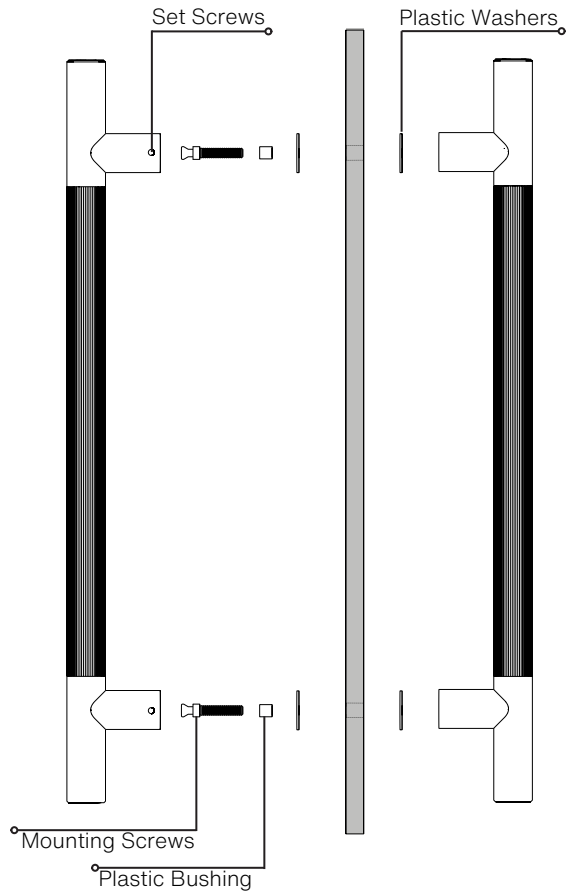

Side View

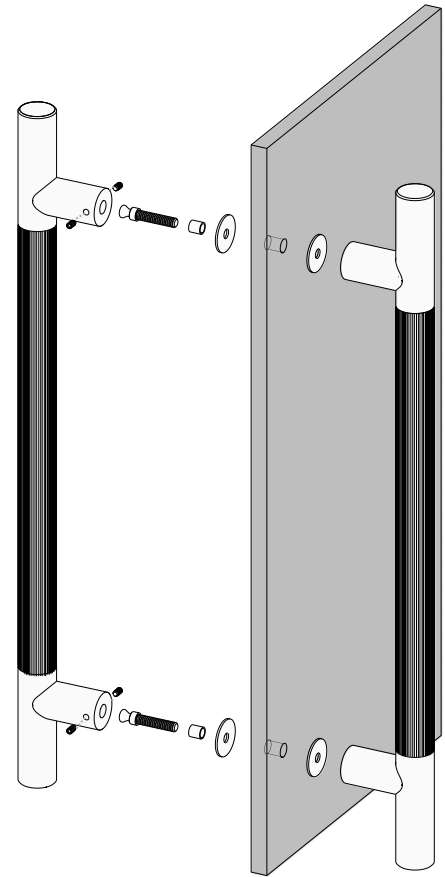

Axonometric View

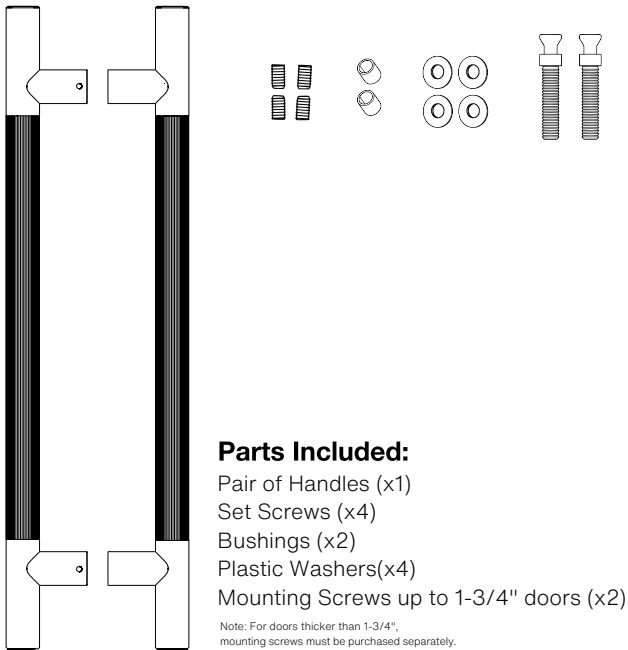

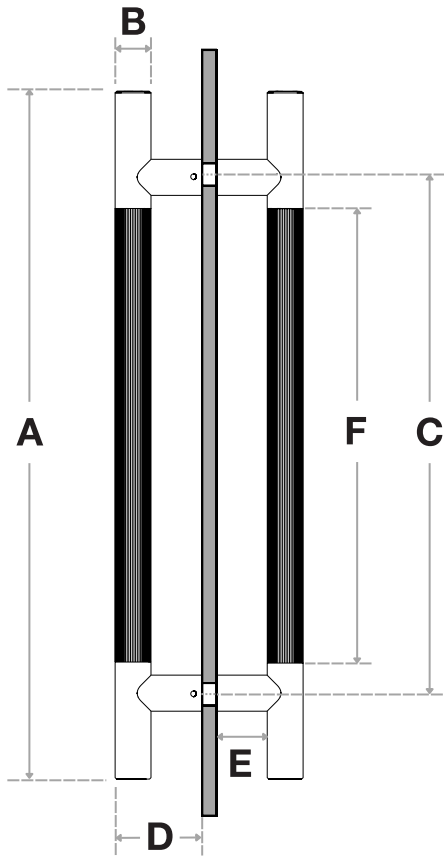









Handle Length (A)	Diameter (B)	Center-to-Center (C)	Projection (D)	Clearance (E)	Fluted (F)
12"	1-1/4"	6"	3"	1-3/4"	4-3/4"
18"	1-1/4"	12"	3"	1-3/4"	10-3/4"
24"	1-1/4"	18"	3"	1-3/4"	16-3/4"
36"	1-1/4"	30"	3"	1-3/4"	28-3/4"
48"	1-1/4"	42"	3"	1-3/4"	40-3/4"
60"	1-1/4"	54"	3"	1-3/4"	52-3/4"

Side View

GRIP FINISHES (1):

-  Brushed Satin = S
-  Matte Black Powder Coated = B
-  Satin Brass = SB

ENDS FINISHES (2):

-  Brushed Satin = S
-  Polished = P
-  Matte Black Powder Coated = B
-  Satin Brass = SB
-  Matte White Powder Coated = W

OVERALL LENGTHS (3)

- 12" = 12
- 18" = 18
- 24" = 24
- 36" = 36
- 48" = 48
- 60" = 60

DIAMETER (4)

- 1-1/4" = 1250

For a complete **SKU#** add Grip Finish (1), Ends Finish (2), Overall length (3) and Diameter (4)

SH-PRO-316-LPH-D-FLU- - - -

GRIP FINISH ENDS FINISH OVERALL LENGTH DIAMETER

DOOR TYPE	GLASS DOORS UP TO 3/4"	WOOD & METAL DOORS UP TO 4-3/4"
HOLE SIZE DIAMETER	5/8"	5/16"

Not all Finishes, Lengths and Diameters are available in this style.

For customization requests, please contact us at info@strongarhardware.com